

HIG24VDC-L/T

- Insulation monitoring devices HIG24VDC(-L), HIG48VDC(-L), HIG72VDC(-L), HIG110VDC(-L) are designed for the monitoring of the insulation status of DC IT systems with nominal voltage 24 V DC, 48 V DC, or 72 V DC or 110 V DC.
- The device continuously monitors the insulation status of both branches of the isolated IT system against a reference point. For stationary equipment this is usually the PE conductor, for mobile equipment it is the vehicle frame.
- If the insulation condition in the positive branch R+ or negative branch R- is faulty, this condition is signalled by setting relay KA1/KA2. The fault condition is also indicated by LEDs on the front panel.

- These devices are equipped with a display for showing the currently measured values. The display, together with the buttons is also used to set the device.
- HIG24VDC(-L)/T, HIG48VDC(-L)/T, HIG72VDC(-L), HIG110VDC(-L)/T are designed for railway use (EN 50155) to monitor the insulation condition of DC IT systems.

Type		HIG24VDC-L/T
Monitored IT power supply system type according to IEC 61557-8		DC
Measuring range of insulation resistance	R_F	$2 \div 550 \text{ k}\Omega$
Adjustable range of critical insulation resistance	R_{an}	$2 \div 500 \text{ k}\Omega$
Number of insulation resistance fault levels (R_{an})		1
Rated voltage of monitored IT system (DC)	U_n	24 V
Nominal supply voltage DC	U_s	$12 \div 36 \text{ V}$
IMD power supply		From measured IT system
Power consumption	P	2 VA
Measuring input's internal impedance	Z_i	$> 55 \text{ k}\Omega$
Internal DC resistance	R_i	$> 55 \text{ k}\Omega$
Measuring accuracy		$\pm 10 \%$
Equipped with display		Yes (OLED technology)
Supported module of distant signalisation (MDS)		MDS-D, MDS-DELTA
Communication interface for user		RS485 bus
Communication protocol		ISOLGUARD
External control inputs		Test start, Deblocking function
Housing material		Polyamid PA6, UL94 V-0
Electrical strength against internal circuits		3 750 V
Degree of protection of front panel		IP40
Degree of protection except the front panel		IP20
Operating temperature	ϑ	$-25 \div 70 \text{ }^\circ\text{C}$
Storage temperature		$-40 \div 70 \text{ }^\circ\text{C}$
Protection class according to IEC 61140		II
Recommended cross-section of connected conductors	S	1 mm^2
Installation		On DIN rail 35 mm

Type		HIG24VDC-L/T
Modular width		2 TE
Recommended back-up fuse		6 A/gG
Use for traction		Yes
Operating position		Any
Operation type		Permanent
Designed according to standards		
Insulation monitoring devices for IT systems		IEC 61557-8:2014
Equipment for testing, measuring or monitoring of protective measures		IEC 61557-1:2007
Insulation coordination for equipment within low-voltage systems		IEC 60664-1:2007
Railway applications – Rolling stock – Electronic equipment		EN 50155:2017
Railway applications – Rolling stock equipment – Shock and vibration tests		IEC 61373:2010
Railway applications – Fire protection on railway vehicles		EN 45545-2:2013
Railway applications – Electromagnetic compatibility		EN 50121-3-2:2016
Application standards		
Low-voltage electrical installations – Protection against electric shock		HD 60364-4-41:2017
Ordering, packaging and additional data		
Mass	m	147 g
Mass (including the packaging)	m	171 g
Packaging dimensions (H x W x D)		60 x 113 x 73 mm
Packaging value	V	0.5 dm ³
Customs tariff no.		90303370
EAN code		8590681174111
Art. number		70 933L/T



The link in the QR code leads to the online presentation of the HIG24VDC-L/T . There, in addition to the always up-to-date data sheet, you will also find all diagrams and drawings, declarations of conformity, or 2D or 3D models and other necessary materials. For more information, visit www.hakil.com



8590681174111

Application wiring diagram (installation) 1/2

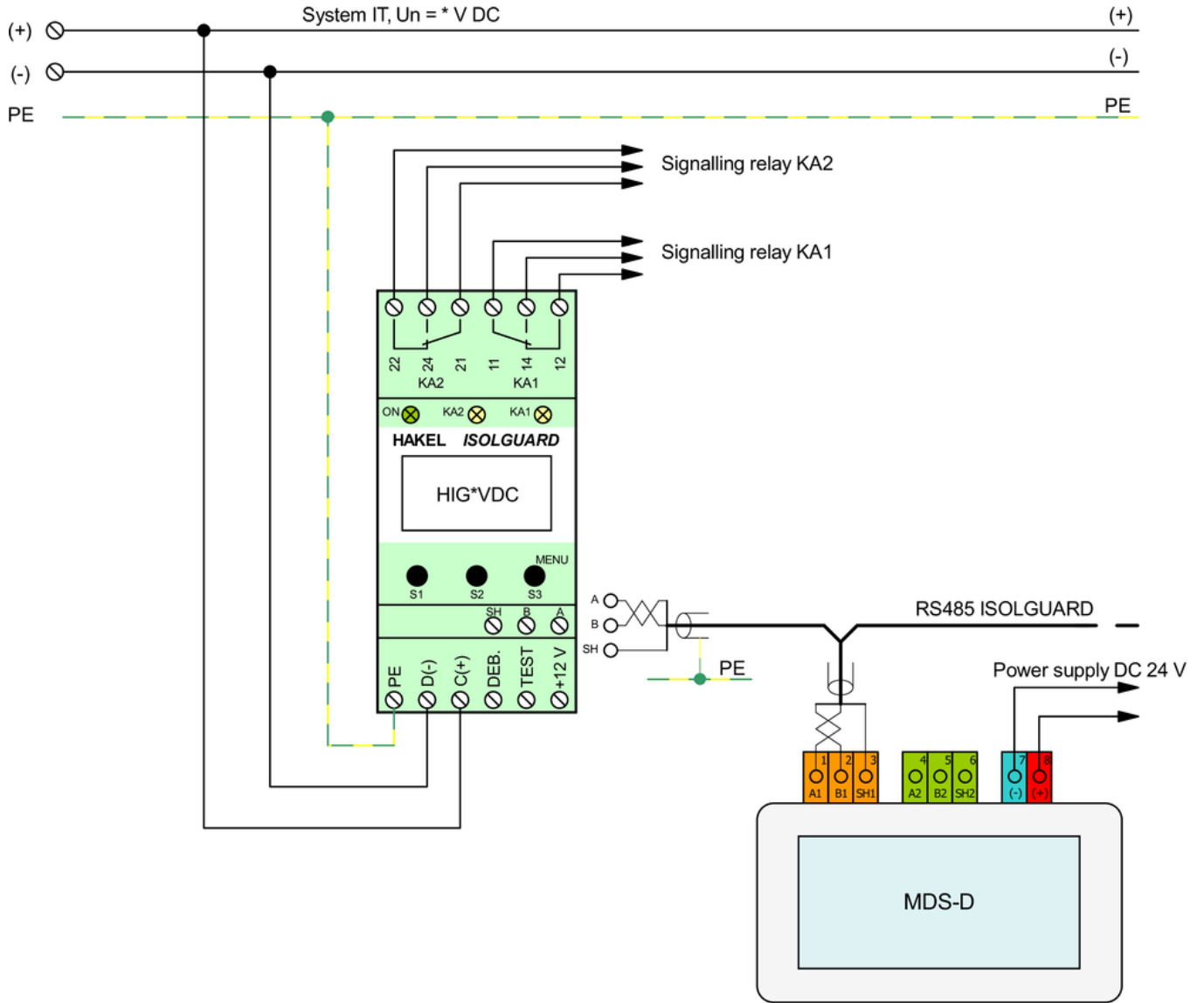

Application wiring diagram (installation) 2/2

